

EM83 *Helix* Conveyor

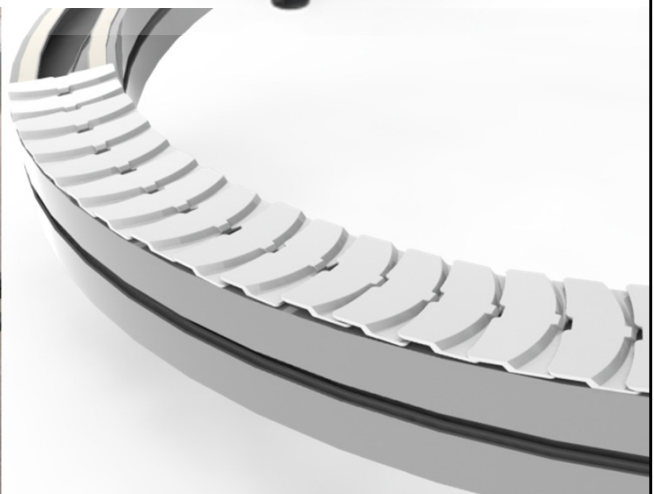

New FlexMove *Helix* Conveyor

- FlexMove new Helix conveyor is compactly structured solution to elevate products up and down saving precious production space.
- FlexMove Helix conveyor is used as buffer conveyor or as bridge to another height allowing passage way below the conveyor.
- FlexMove Helix conveyor simple, reliable and continuous run conveying solution for wide applications.
- The Helix conveyor uses in wide applications handling small items to light to medium packed items or cartons.
- Aluminium Frame and Structure.
- Mild Steel Zink Plated Leg support.



EM83 *Helix* Conveyor

HX 3-U T3-IF900-OF2200-CW-R500

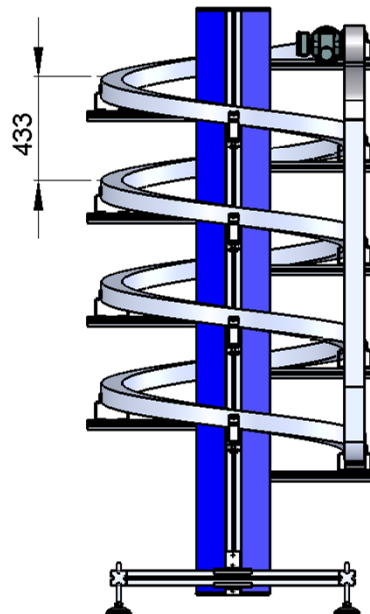
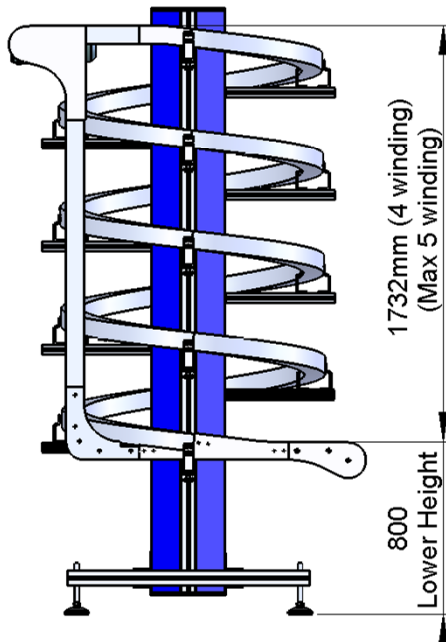
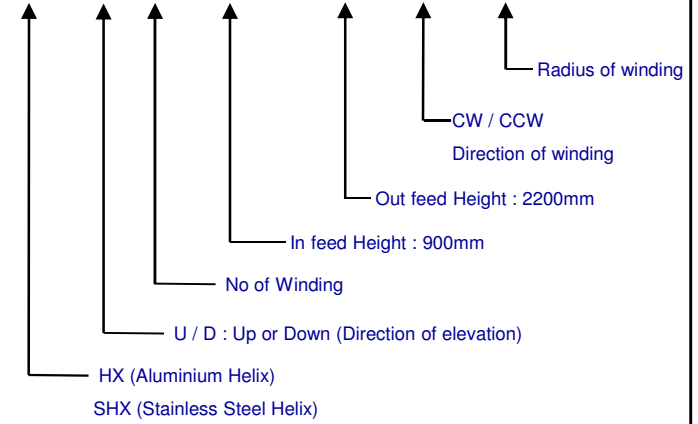
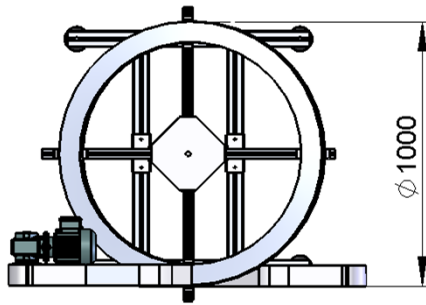

Technical Specifications

- 433mm inclination per winding (7 Degree)
- Max. 5 Winding
- 1000mm center diameter
- Speed 5-30 meter/min
- Lower height 800, 900, 1000mm +/- 50mm
- Max load 5 kg/m
- Max product height 200mm
- Drive and idler are horizontal position at infeed and outfeed
- Chain width 83mm
- Plain and friction top chain
- Special low friction chain

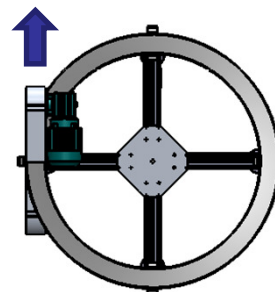

CW Direction of winding

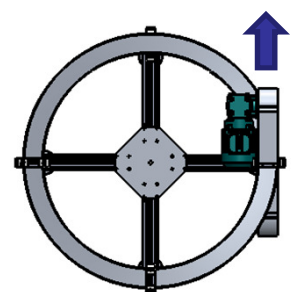

CCW Direction of winding